

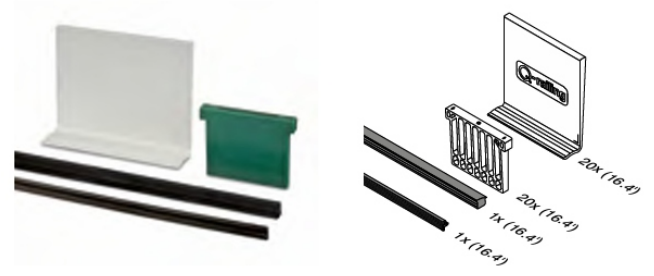

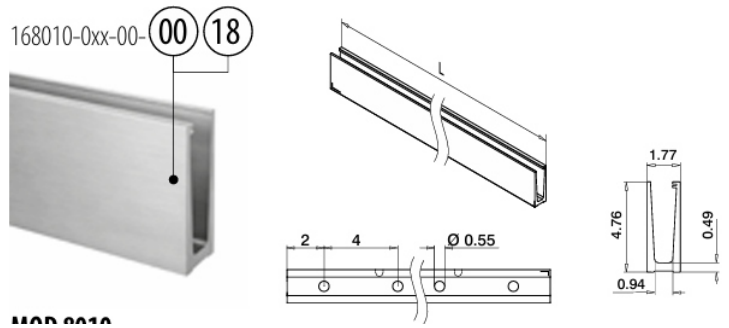

Please refer to the respective certificates and static calculations for specifications such as mounting details, glass dimensions and glass types.



EASY GLASS® SLIM

Mounting / For MOD	t (inch)	Anchor	QS	Type	fix T (inch)	☒	Anchor	QS	Type	fix T (inch)	☒
Top / MOD 8010		Mechanical	FOR CONCRETE					FOR STEEL			
	0.49		QS-36	Q SZ-SK 12/50	1.45	215		QS-533	M10 x 1.18"	0.39	213
			QS-519	Q SZ-SK 12/50 A4	1.45	215					
			QS-303	KH-EZ 10 x 100	0.078	216					
			QS-304	KH-EZ 10 x 105	0.078	216					
							FOR WOOD				
								QS-250	3/8" x 3.15"	0	217
								QS-251	3/8" x 4.72"	0.39	217

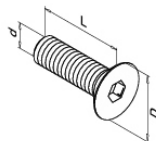

MOD 0670- coarse thread (DIN 7991)

316

	QS	Q	d	D	L	☒
240670-130	QS-533	Q-6	M10-1.50	13/16" (20 mm)	1-3/16" (30 mm)	50

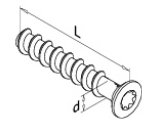

MOD 4314

Steel, zinc-plated

	QS	Q	Type	d	☒	L	☒
254314-100	QS-303	Q-116	KH-EZ 10x100	3/8" (10 mm)	3/8" (10 mm)	4"	50

316

244314-105	QS-304	Q-116	KH-EZ 10x105	3/8" (10 mm)	3/8" (10 mm)	4-1/8"	50
------------	--------	-------	--------------	--------------	--------------	--------	----

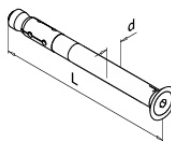

MOD 4210

Steel, zinc-plated

	QS	Type	d	☒	L	☒
254210-212	QS-36	Q SZ-SK 12/50	0.47" (12 mm)	Ø 15/32" (12 mm)	4-23/32" (120 mm)	25

316

244210-212	QS-519	Q SZ-SK 12/50 A4	0.47" (12 mm)	Ø 15/32" (12 mm)	4-23/32" (120 mm)	25
------------	--------	------------------	---------------	------------------	-------------------	----

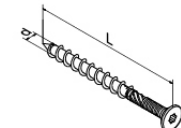

MOD 0260

Steel, zinc-plated

	QS	Q	d	L	☒
250260-008	QS-250	Q-113	3/8" (10 mm)	3.15" (80 mm)	50
250260-012	QS-251	Q-113	3/8" (10 mm)	4.72" (120 mm)	50